

*english*



^  
geovane

Wind direction  
measurements reinvented

*A product developed by Kintech Engineering*



# GEOVANE

## WIND DIRECTION MEASUREMENTS REINVENTED

*A patented invention to finally resolve the inherent uncertainties in traditional wind direction measurement*



During the development phase of a wind farm, apart from obvious wind vane installation mistakes, developers are facing several additional difficulties when measuring wind direction:

**1**

*The physical impossibility of verifying the wind vanes final orientation on the boom.*



**2**

*When wind vane alignment is carried out using a magnetic compass it is necessary to compensate for the Earth's magnetic field distortions such as the presence of the nearby met mast metal structure, and for the magnetic declination for the location, which in addition alters over time.*

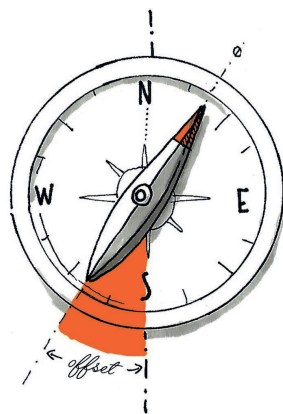

**3**

*Complete met mast and sensor boom can bend and twist, altering the wind direction measurements over time.*

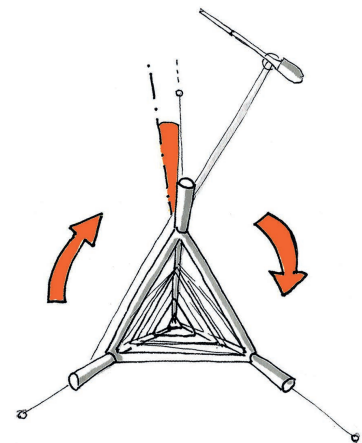

Perfectly aligned wind vanes with zero offset between them in no way means either of the wind vanes is correctly aligned towards True North. What's more, despite the common misconception, adding more wind vanes does NOT resolve this issue.

# WIND DIRECTION MATTERS

Wind direction data has immediate effect on wind development projects and wind turbine performance. Imprecise wind direction measurements may result in:

*\*See example for 24MW wind farm online*

- 1** *Inaccurate AEP calculations\**
- 2** *Unforeseen wake effect losses because of turbine misalignment\**
- 3** *Higher than expected turbine loads and therefore lower turbine service-life\**

# FOR MET MASTS & RSD THE GEOVANE WILL



*Find True North and consequently provide absolute and accurate offset values for wind vanes*

*Guarantee the most accurate direction measurements available in the industry*

*Drastically reduce wind direction uncertainty by more than 500%!!!*

*Continuously provide the True North offset value for correcting misalignment due to a twisted measurement mast or bended sensor booms*

# APPLICATIONS

The Geovane can be used in 4 different applications:

## **geovane\_metmast\_verification**

*Install it on existing wind measurement masts and use it to correct existing datasets.*



## **geovane\_metmast**

*For upcoming wind measurement masts and power performance tests.*

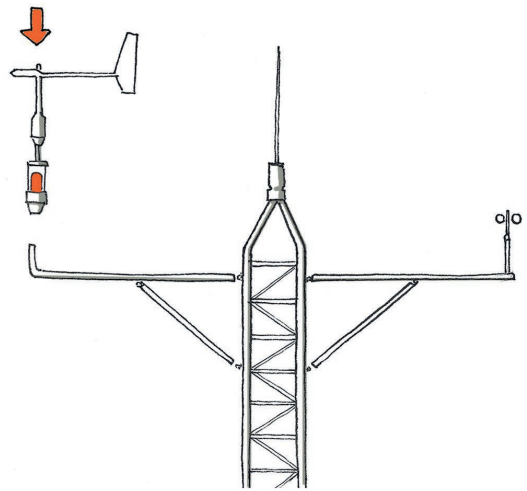

## **geovane\_turbine**

*Precision alignment of wind turbines for advanced sector management.*

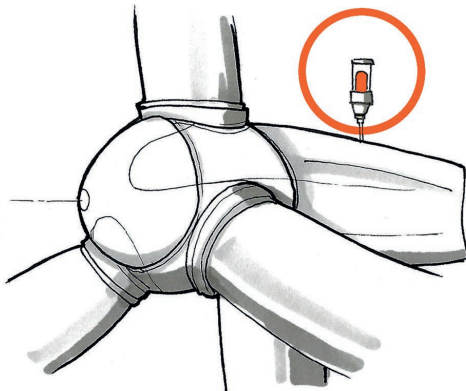

## **geovane\_RSD**

*Precision alignment of field deployed sodars and lidars.*

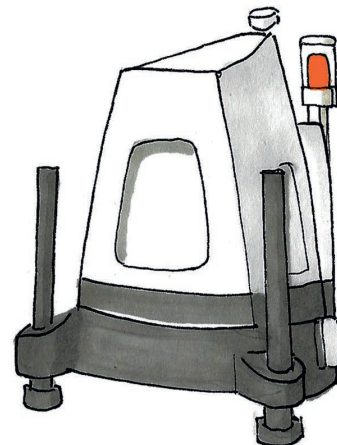

# HOW WILL THIS AFFECT YOUR DEVELOPMENT PROJECT OR WIND FARM?

*More accurate AEP calculations (see example for 24MW wind farm)*

*Avoid unforeseen wake effect losses*

*Extract the full power potential from your turbines*

*Extend your turbine service-life*



## HOW GEOVANE WORKS?

The Geovane's patented design is equipped with high-resolution optoelectronic sensors composed of 1024 photosensing pixels. This allows the Geovane to use the Sun to measure the True North offset of the sensor mounted on top of it.

Geovane obtains the True North wind vane offset by comparing the theoretical solar azimuth angle calculated by its embedded processing unit with the measured azimuth value read by its built-in photosensing pixels.

### GPS

*The GPS module provides the location, date, and time to the internal processing unit, enabling Geovane to calculate the theoretical solar azimuth.*

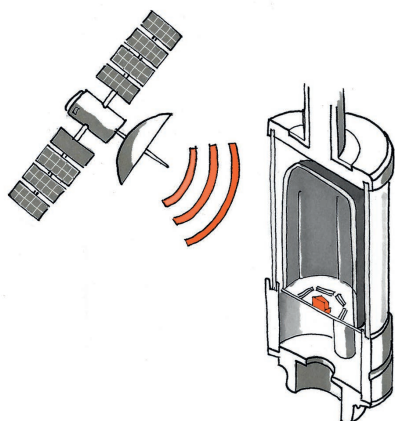

### PHOTOSENSING PIXELS

*Using the very fine sunrays that pass through the Geovane's precision slits in combination with the internal photosensing pixels allows the Geovane to measure changes in the Sun's position at a resolution below 0.06°!*

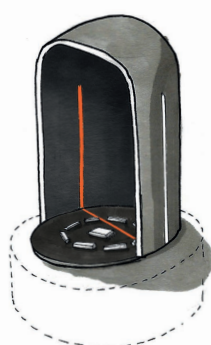

### GYRO & ACCELEROMETER

*The integrated tilt sensor permits comparing the theoretical and measured solar azimuth, even if the Geovane is not perfectly leveled.*

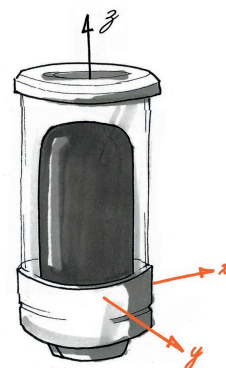

### LASER BEAM EMITTER

The Geovane includes a high-precision laser beam emitter used to fixate its position with respect to the wind vane.

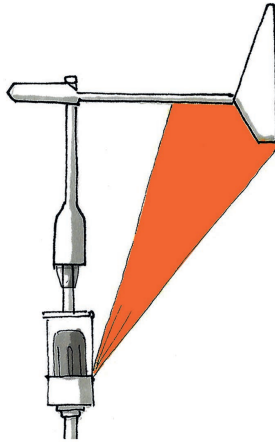

### INTERFACE

The Geovane is equipped with both analog outputs and an RS485 driver for convenient interface and communication with industry standard data loggers.

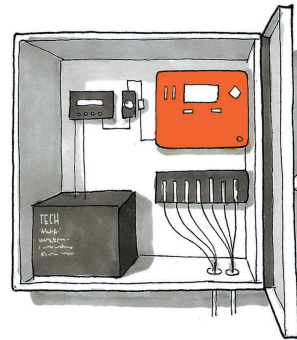

### PRECISION SLITS

Internal heat and UV resistant molded plastic cup with fine slits for sunrays to pass through. Precision cut glass tube houses the Geovane, providing added protection for internal components from harsh weather conditions.

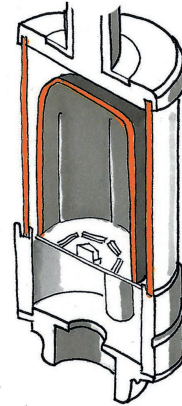

### ESD PROTECTIONS

Efficient power management and ESD protections: designed for installation in remote locations equipped only with solar power supply.

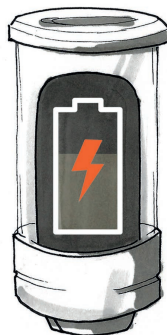

### ON/OFF SWITCH

Smart programmable on/off switch to operate an external relay for e.g. obstruction lights, heating, pyranometer ventilation units, etc. Programmable timer based or using sun coordinates (e.g. sunrise, noon, sunset...).

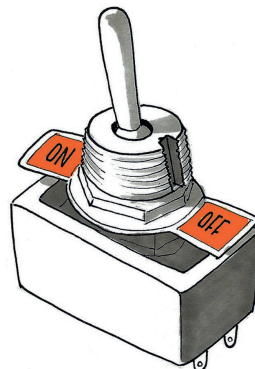

### ADAPTOR ROD

The Geovane's adaptor rod allows it to be fitted to any industry standard wind vane, ultrasonic anemometer, or even remote sensing device such as a sodar or lidar.

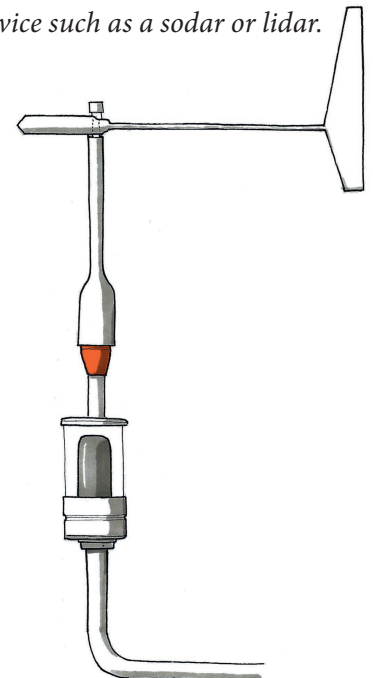

## TECHNICAL SPECIFICATION

CHARACTERISTIC	DESCRIPTION
Operating voltage	6... 30V
Measurement rate	1s, 10s, 30s, 60s
Consumption	5mA at 12V and 10s (1.5mA at night)
Measurement range	0... 360°
Reference	Geographic North (True North)
Field of View (FOV)	360° (azimuth) and 62° (elevation)
Absolute accuracy	<1°
Resolution	<0.06°
Digital output	RS-485 (9600, 8N1)
Frequency output	10... 130Hz push-pull with 220Ω series resistance
Analog outputs	12-bit resolution 0.5... 4.5V with 220Ω series resistance
Temperature range	-25... 85°C
Weight	0.870Kg
Dimensions	180 x Ø80mm (w/o adaptor)
Mounting	Onto mast tube Ø34mm



## INTERESTING FACTS

**1** The project has received funding from The Centre for the Development of Industrial Technology (CDTI) in Spain. For this process, it went through rigorous lab, real life trials and audits.

**2** The Technical University of Zaragoza, Spain assisted during the development of the Geovane providing advanced mathematical shadow algorithms.



*For more information contact us on [sales@geovane360.com](mailto:sales@geovane360.com)  
or go to [www.geovane360.com](http://www.geovane360.com)*

*Last modified 12/12/2018*